

FACTORY FURNITURE

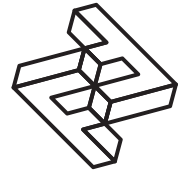

TOPHAT planter (2.4 x 0.5m)

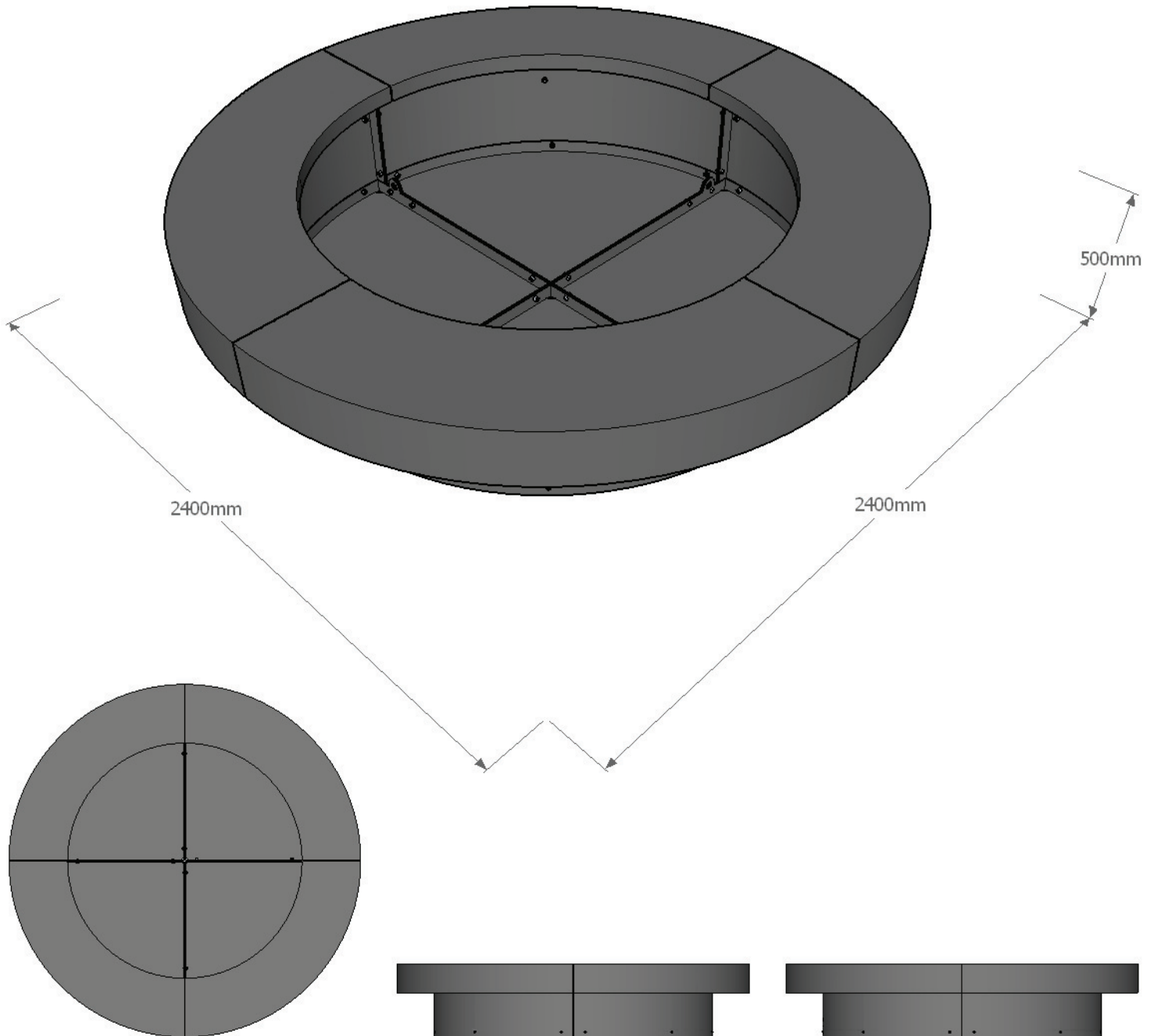

SPECIFICATIONS

Composition

Galvanised mild steel* or option for Corten steel

Finish

Polyester powder coated finish (colour - grey as standard or to customer specification)

Dimensions

Metric L 2400mm | width 2400mm | height 500mm

Imperial L 7' 10½" | width 7' 10½" | height 1' 7½"

Planter capacity 1200ltrs

Approx weight 335kg

Handling

Please observe health & safety lifting guidelines. A fork lift or crane will be required for off-loading and positioning of item. Integral lifting eyes provided.

Maintenance

Depends on usage and position. All elements require annual cleaning. Galvanised and powder coated mild steel parts only require maintenance if damaged. Corten steel requires no maintenance.

**Please note that when a powdercoat is applied over a hot dip galvanised surface pinholing can occur in the surface finish - this is not considered a defect.*